

Temperature dependence of fracture toughness of epoxy resins cured with diamines

KIYOSHI MIZUTANI, MINORU YOSHII

Osaka Prefectural Industrial Research Institute, Takaida-naka 1-38, Higashi-Osaka 577, Japan

The fracture toughness (critical stress intensity factor, K_{Ic}) of epoxy resins cured with four diamines has been measured as a function of temperature over the range from -35°C to above T_g . It was found that K_{Ic} for each epoxy-diamine system did not vary below room temperature, and in the higher temperature range K_{Ic} increased with increasing temperature to a maximum and then decreased. The temperature which maximized K_{Ic} , agreed with the temperature at which the flexural modulus of the epoxy resins abruptly dropped. This temperature was therefore considered as T_g . This temperature was found to be about 20°C lower than the heat deflection temperature under load (1.82 MPa) of the resins.

1. Introduction

The effect of temperature on the fracture toughness of brittle thermoplastics, such as poly(methyl methacrylate) (PMMA) and polystyrene (PS), has been studied using a linear elastic fracture mechanics (LEFM) approach. Several investigators have reported that the fracture toughness of the above glassy polymers increased with decreasing temperature over a range of -50°C to the glass transition temperature (T_g) [1, 2]. In a previous paper the temperature dependence of the critical stress intensity factor (K_{Ic}) of PMMA was investigated [3]. It was found that K_{Ic} decreased with increasing temperature over the range of -35 to $+60^{\circ}\text{C}$. However, K_{Ic} increased near T_g , and reached a maximum at T_g ; it then dropped off with increasing temperature.

On the other hand, the LEFM approach is now well established for thermosetting polymers. In particular, the fracture properties of epoxy resins have been studied from several points of view [4, 5]. It was reported that the fracture toughness of epoxy resins did not vary in the low temperature range, and increased with increasing temperature up to T_g [6-9].

In this paper, K_{Ic} for epoxy resins cured with diamines was measured in the temperature range from -35°C to above T_g for the resins, and the effect of temperature on the fracture toughness of the epoxy resins will be discussed.

2. Experimental procedure

2.1. Materials

The epoxy resin used was a commercial diglycidyl ether of bisphenol-A (Epikote 828, epoxy equivalent 190 ± 5 , Yuka-Shell Epoxy Co.). Four diamines were used as curing agents: 3,9-bis(3-aminopropyl)-2,4,8,10-tetroxaspiro(5,5)-undecane (ATU), m-xylylenediamine (XD), m-phenylenediamine (PD) and isophoron-diamine, 1-amino-3-aminomethyl-3,5,5-trimethyl cyclohexane (IPD) (Wako Pure Chem. Ind. Ltd.) (Fig. 1). These curing agents were commercial-grade materials and were used without further purification.

The resin and curing agent were thoroughly mixed and degassed at the curing temperature, and then cast between glass plates 6 mm apart. The amounts of curing agents added to the resins, the curing temperature and the postcure temperature are shown in Table I.

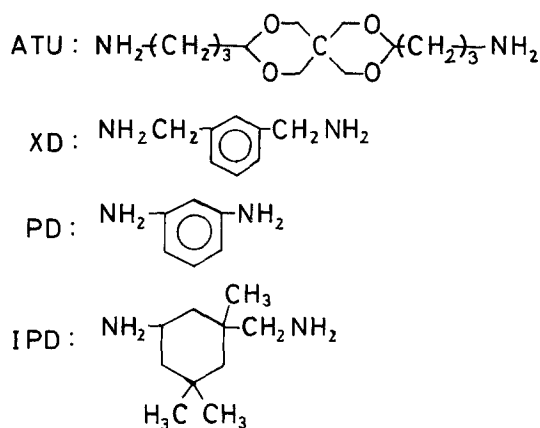

Figure 1 Curing agents.

Figure 2 Tapered double cantilever beam specimen; $b = 6 \text{ mm}$, $w = 3 \text{ mm}$, $a = 25$ to 70 mm .

TABLE I Curing agents and curing conditions

Curing agent	Amount (p.h.r.)*	Curing conditions
ATU	50	Room temp., 1 day + 80°C, 3 h
XD	17	Room temp., 1 day + 100°C, 2 h
PD	15	80°C, 1 h + 150°C, 4 h
IPD	24	80°C, 1 h + 150°C, 4 h

*Parts per hundred parts of resin.

2.2. Specimens and measurements

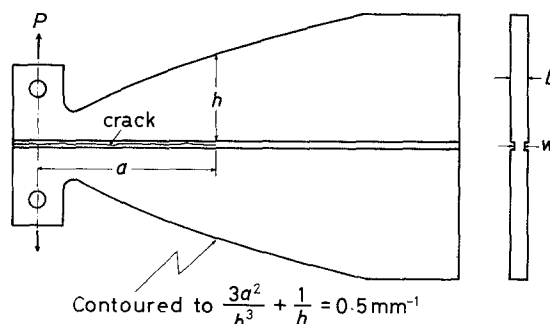
Measurements of the fracture toughness were carried out on a tapered double cantilever beam (T-DCB) specimen, as shown in Fig. 2. This specimen was machined from the moulded plate. A precrack that had a very small crack-tip radius was formed by applying a cyclic load on the T-DCB specimen at room temperature. For this T-DCB specimen, the stress intensity factor (K_I) is given by [10, 11]:

$$K_I = \frac{2P}{(bw)^{1/2}} \left(\frac{3a^2}{h^3} + \frac{1}{h} \right)^{1/2} \quad (1)$$

where P , a , w , b and h are the applied load, the crack length, the plate thickness in the plane of the crack, the beam width, and the beam height measured normal to the crack tip, respectively. This test specimen was tapered in such a shape that

$$\frac{3a^2}{h^3} + \frac{1}{h} = 0.5 \text{ mm}^{-1}$$

Thus, K_I becomes independent of the crack length and can be readily determined by measuring the load P .

The measurements of K_{Ic} were carried out in an Instron testing machine with an environment chamber at a cross head speed of 0.5 mm min^{-1} . All specimens were left in place for 5 to 20 min before testing. In addition, the flexural properties of the epoxy resin were measured over the same range of temperature according to the ASTM method D 790.

3. Results and discussion

3.1. Behaviour of crack propagation

Three different types of load–displacement curve which arise from different modes of crack propagation are illustrated schematically in Fig. 3. Type 1 is continuous stable crack propagation (Fig. 3a), which was observed at low temperatures for every epoxy resin cured with diamine. In this case the speed of the crack propagation, which varied with temperature and crack length, was 5 to 20 cm min^{-1} (the speed of crack growth increased with decreasing temperature). Type 2 is a stick–slip behaviour or a crack jump-

ing (Fig. 3b). This type of crack propagation was observed in the medium temperature range, from room temperature to the T_g of the resins. Type 3 crack propagation (Fig. 3c) was observed at high temperatures (above T_g). In this case, the crack propagation was accompanied by plastic deformation of the beams of the T-DCB specimens and the formation of a shear lip on the fracture surface. Therefore, in this case it is impossible to calculate accurate values of K_{Ic} using Equation 1. However, Equation 1 could be used in calculating K_{Ic} in order to compare with the values of K_{Ic} obtained in other crack propagation modes.

3.2. Fracture toughness and Young's modulus

The fracture toughness (K_{Ic}) and flexural modulus (E_f) of epoxy resins cured with four diamines are shown in Figs 4 to 7 as a function of test temperature. It was found that below room temperature the values of K_{Ic} were almost constant for a given epoxy resin. In the cases of ATU (Fig. 4) and XD (Fig. 5), K_{Ic} increased vigorously above room temperature, reached a maximum at 55 and 80°C, respectively, and then dropped off with increasing temperature. Also, in the cases of PD (Fig. 6) and IPD (Fig. 7) K_{Ic} gradually increased with increasing temperature above room temperature and reached a maximum at 140 and 150°C, respectively. On the other hand, the flexural moduli gradually decreased with increasing temperature and vigorously decreased above a certain temperature in every epoxy–diamine system. It was found that these temperatures agreed with the temperatures at which the maximum values of K_{Ic} was observed. Therefore, these temperatures could be considered as the T_g values of the resins. It was also found that these temperatures were about 20°C lower than the heat deflection temperature under load (1.82 MPa) and also about 20°C lower than T_g as determined from $\tan\delta$ –temperature curves.

It was considered that micro-Brownian movement of polymer chains began to occur near the temperature at which the E_f –temperature curves revealed a shoulder. That is, the occurrence of a plastic deformation at the crack tip became very easily near the

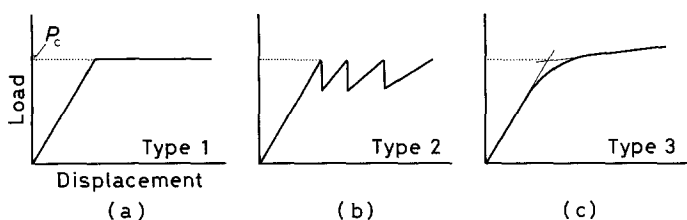

Figure 3 Typical curves of load against displacement for T-DCB specimen during crack propagation.

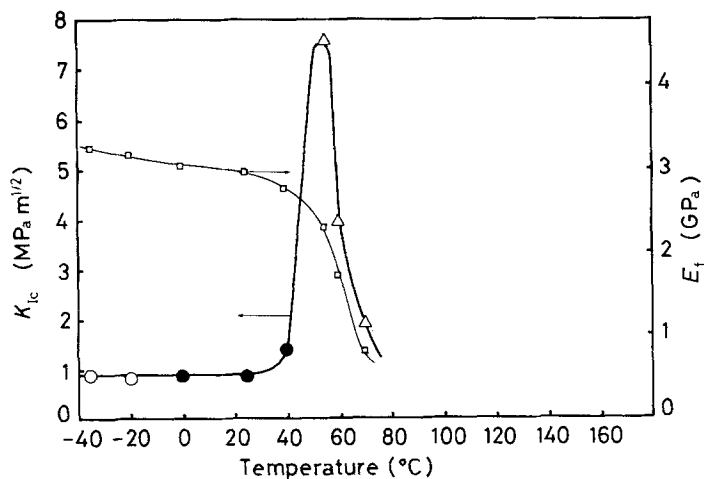

Figure 4 Fracture toughness (K_{Ic}) and (\square) flexural modulus (E_f) as a function of temperature for epoxy resin cured with ATU. Crack propagation: (\circ) Type 1, (\bullet) Type 2, (Δ) Type 3.

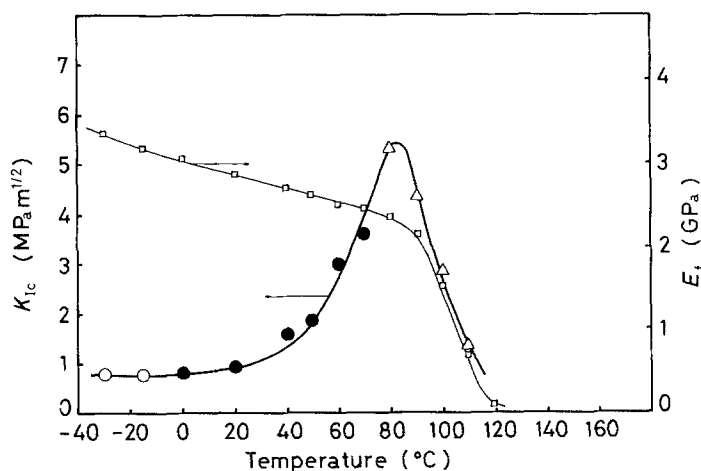

Figure 5 Fracture toughness (K_{Ic}) and (\square) flexural modulus (E_f) as a function of temperature for epoxy resin cured with XD. Crack propagation: (\circ) Type 1, (\bullet) Type 2, (Δ) Type 3.

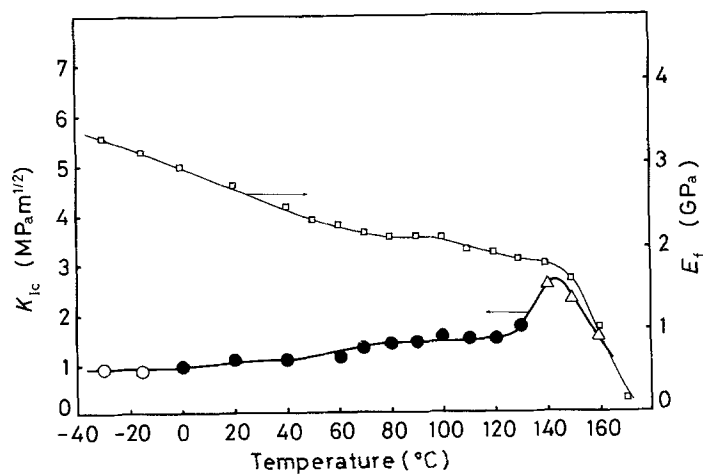

Figure 6 Fracture toughness (K_{Ic}) and (\square) flexural modulus (E_f) as a function of temperature for epoxy resin cured with PD. Crack propagation: (\circ) Type 1, (\bullet) Type 2, (Δ) Type 3.

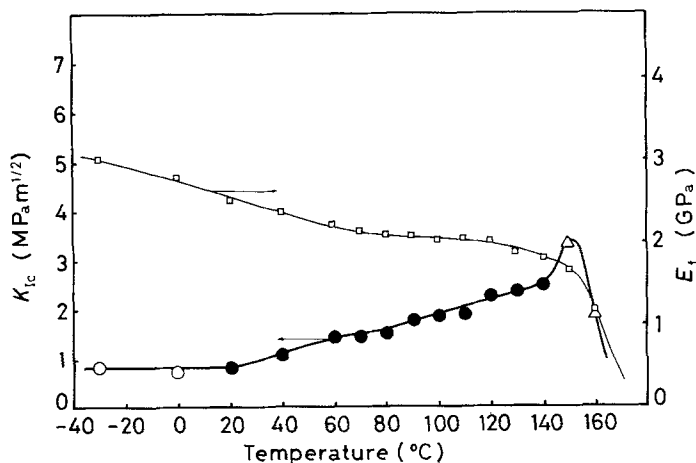

Figure 7 Fracture toughness (K_{Ic}) and (\square) flexural modulus (E_f) as a function of temperature for epoxy resin cured with IPD. Crack propagation: (\circ) Type 1, (\bullet) Type 2, (Δ) Type 3.

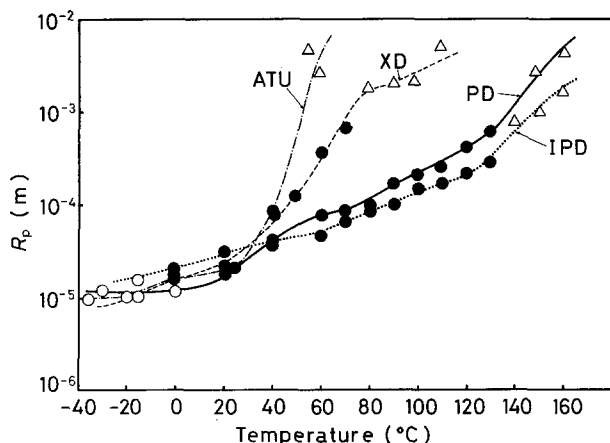

Figure 8 Length of plastic deformation zone at crack tip (R_p) as a function of temperature for epoxy resins cured with four diamines. Crack propagation: (O) Type 1, (●) Type 2, (Δ) Type 3.

above temperature, so that K_{Ic} became very large. However, above T_g , the Young's modulus and the yield strength became very small, so that K_{Ic} became very small.

3.3. Length of plastic deformation zone at crack tip

It is known that plastic deformation occurs at the crack tip during crack growth in brittle polymers. The length of the plastic deformation zone at the crack tip (R_p) is related to the fracture toughness K_{Ic} by:

$$R_p = \frac{\pi K_{Ic}^2}{8 \sigma_y^2}$$

where σ_y is the yield strength. If the flexural yield strength measured according to the ASTM method is regarded as σ_y , the R_p -temperature curves in Fig. 8 can be obtained. Below 0°C the values of R_p were almost constant (10 to $15\ \mu\text{m}$) and the crack propagation mode was Type 1. In the medium temperature range (from room temperature to T_g), R_p increased with increasing temperature and the crack propa-

gation was of Type 2. Above T_g , R_p became larger than $1000\ \mu\text{m}$ and the crack propagated in the manner of Type 3.

4. Conclusions

The temperature dependence of fracture toughness of epoxy resins cured with diamines was investigated. It was found to be as follows. In the low temperature range, K_{Ic} and R_p were almost constant and the crack propagated continuously. In the range from room temperature to T_g , K_{Ic} and R_p increased with increasing temperature and the crack propagated in a stick-slip manner. Above T_g , a plastic deformation of the beams of the specimens occurred and K_{Ic} decreased with increasing temperature. Also, R_p became larger than $1000\ \mu\text{m}$. It was concluded that at T_g a large plastic deformation at the crack tip occurred, but the Young's modulus and the yield strength did not become so small at T_g , so K_{Ic} reached a maximum at T_g .

References

1. L. J. BROUTMAN and F. J. MCGARRY, *J. Appl. Polym. Sci.* **9** (1965) 589.
2. G. P. MORGAN and I. M. WARD, *Polymer* **18** (1977) 87.
3. K. MIZUTANI, *J. Mater. Sci. Lett.* **6** (1987) 915.
4. K. MIZUTANI and T. IWASAU, *J. Appl. Polym. Sci.* **26** (1981) 3447.
5. *Idem*, *Polym. Eng. Sci.* **23** (1983) 183.
6. S. YAMINI and R. J. YOUNG, *Polymer* **18** (1977) 1075.
7. R. A. GLEDHILL, A. J. KINLOCH, S. YAMINI and R. J. YOUNG, *ibid.* **19** (1978) 574.
8. S. YAMINI and R. J. YOUNG, *J. Mater. Sci.* **15** (1980) 1814.
9. *Idem*, *ibid.* **15** (1980) 1823.
10. S. MOSTOVOY and E. J. RIPLING, *J. Appl. Polym. Sci.* **15** (1971) 641.
11. R. Y. TING and R. L. COTTINGTON, *ibid.* **25** (1980) 1815.

Received 13 October 1987
and accepted 11 February 1988